

Data Sheet



Article number: 5863502813

Description: Ball Valve 350.2813, G 1 1/4" - G 1 1/4"
Thread/Thread

Measures

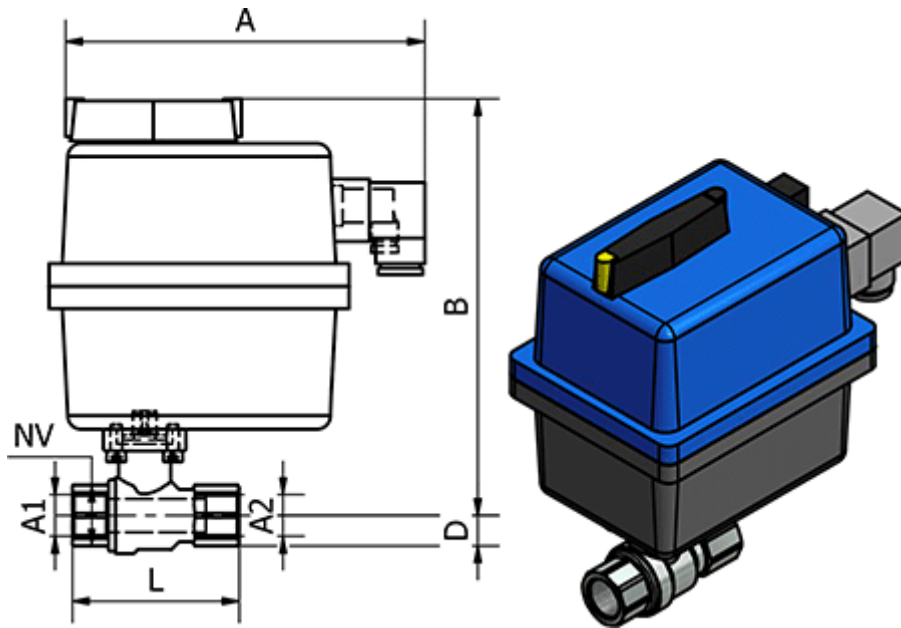

= -	D	= 30
= -	L	= 110
= -	Max. Operating Pressure	= 40 bar
= -	NV	= 50
A	= 177	
B	= 214	
Connecting A1	= G 1 1/4"	
Connecting A2	= G 1 1/4"	